

Data Sheet



Article number: 201576299

Description: E+G Handwheel
GN 950.6-125-K12-F

Measures

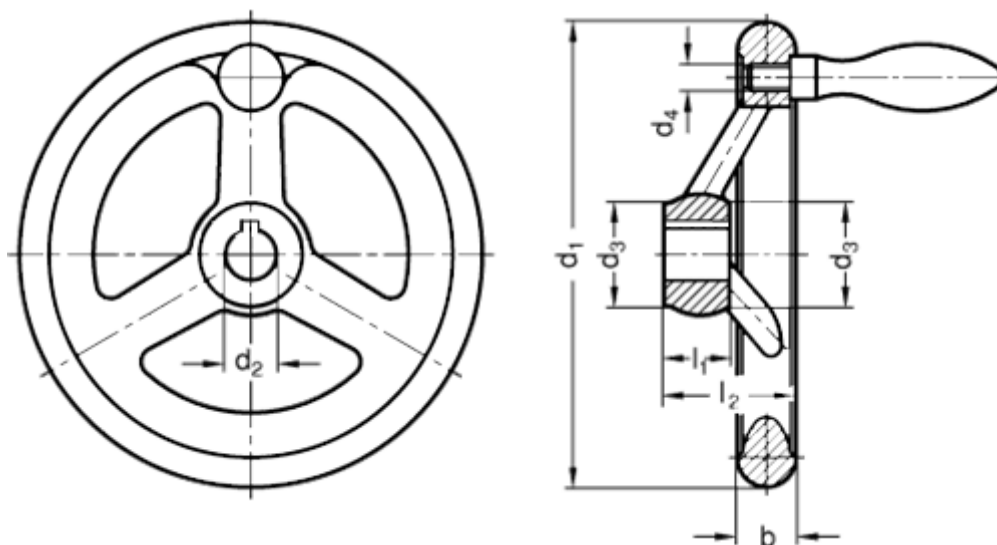

$b_1 = 15.8$

$d_1 = 125$

$d_2 = 12$

$d_3 = 27.0$

$d_4 = M8$

$l_1 = 18$

$l_2 = 35.5$